

# Additional Structure brings Added Value

## Cable ducts from Weidmüller

Let's connect.

Cabinet Infrastructure: Cable Ducts



# Incorporate the structures for flexibility within the cabinet

## Cable ducts as the basis for ordered cable routing

### Additional Structure brings Added Value

Increasing trends in digitalisation require higher packing densities in the cabinet. To maintain order within the cabinet, a clear and space-saving cable routing system is required. This is more than just an optical aspect, because orderly cable routing saves time and money. It facilitates maintenance and repair work and increases general operational safety.

As a partner for Industrial Connectivity, we know the challenges faced and provide you with a comprehensive range of cable ducts and accessories for all applications. Practical details like wire holding lugs for the fixing of already installed wires, as well as precisely punched holes according to DIN EN 50085-2-3, facilitate accurate installation. The clever closing mechanism allows easy latching and ensures a secure fit when closing the lid.

Together, we create sustainable structures with added value. We support you in all work steps from planning through to implementation and ongoing operation. Let's connect.



**Metric**



**DIN**



**Corner cable duct**

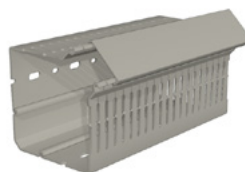

**Halogen-free  
-25 to 105 ° C**



**Halogen-free  
-25 to 120 ° C**



**Protective tube**

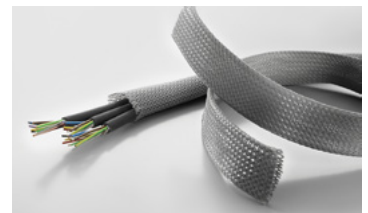

**Equipment**

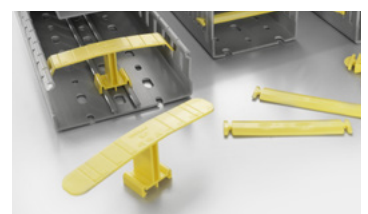

### Perfectly coordinated complete system

Our product range includes cable ducts in metric versions as well as corner and DIN ducts. There are also variants made of halogen-free material. The range is supplemented by protective tubes, holders, separators, and professional marking solutions.

# An complete system that adds real value

## Cable ducts from Weidmüller

Save time and money with quick, easy installation and high flexibility in operation. Our wide product range of cable ducts is complemented with a large number of useful accessories to support your cabinet.

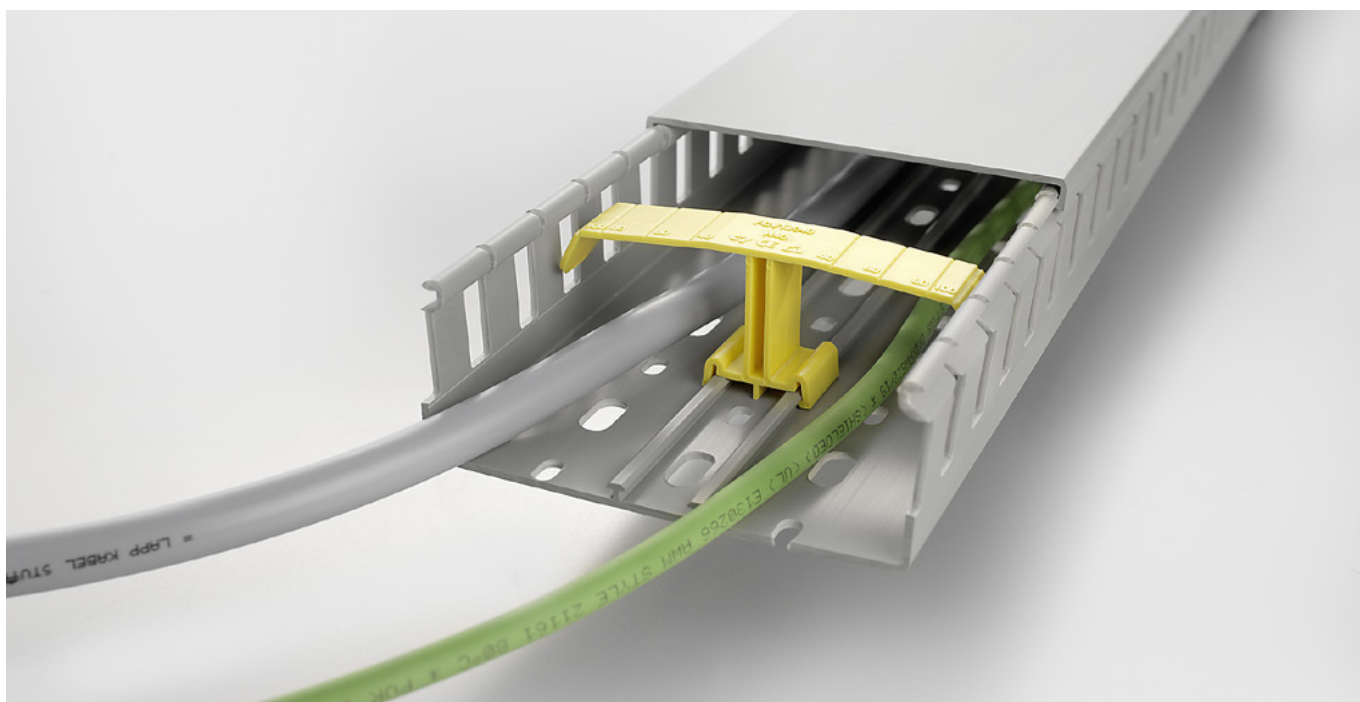

### Flexible system solution

With our cable ducts, we provide you with a flexible wiring system that offers a wide array of accessories and exceptional product features. These include, for example, guide rails for latching holding clamps or dividers. In addition, wire retaining lugs serve as a fixation aid for already installed wires.

### Durable and functional

The superior quality of our cable ducts allows durable structures to be created, for an orderly cable routing within the cabinet. High stability, minimal torsion, and precisely punched bottom holes according to DIN EN 50085-2-3 make the installation quick and easy. The lid can be easily clipped on, its functional locking mechanism guarantees a secure fit.

### Your advantages:

- Comprehensive product range from a single source
- Sophisticated system solution with added value
- High flexibility because of a wide accessory range

# Your easy way to flexible and durable cable routing

## The complete range of cable ducts from a single source

Orderly and flexible cable routing in the cabinet not only gives a good impression, but is also essential for functional and safe operation. With our cable ducts, we offer you a complete range from one source. Benefit from our sturdy, torsion-free cable ducts with clever details for quick and efficient installation.

Our wide range of cable routing systems include metric cable ducts, DIN cable ducts and corner cable ducts.



### Cable ducts

Our cable ducts are available in two basic versions: Metric and DIN. They differ in the slit width and the distance of slots. Ducts with finer slit width are advantageous for applications with small cable cross-sections in conjunction with terminal blocks. The variants designed as corner channels are particularly suitable for control cabinets with limited space and a high line density.

Halogen-free cable ducts offer you more operational safety in areas of increased fire protection.

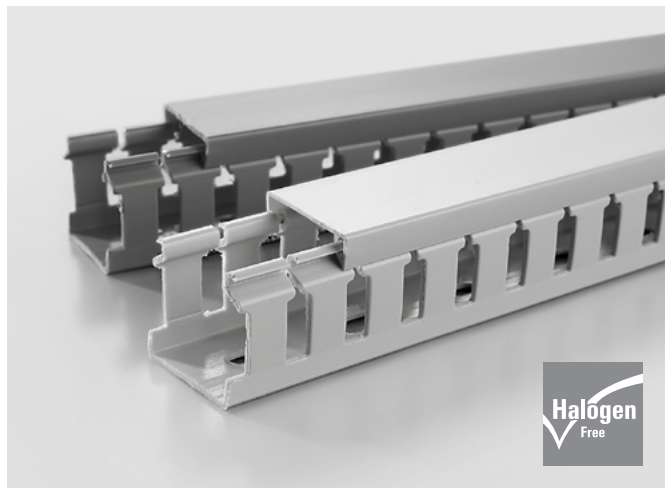

### Halogen-free cable ducts

In applications where increased fire protection is required, our halogen-free cable ducts offer a higher level of operational safety. They are mainly used in traffic engineering, but also in tunnel systems or for building infrastructure. Our halogen-free materials are characterised by low smoke development and non-toxic waste gases.

### Your advantages:

- Sturdy cable ducts without torsion
- Wire holding lugs as a fixation aid
- Precisely punched bottom holes according to DIN EN 50085-2-3
- Secure fitting lid thanks to an optimum locking mechanism

Spiral and webbing hoses bundle and protect your cables.

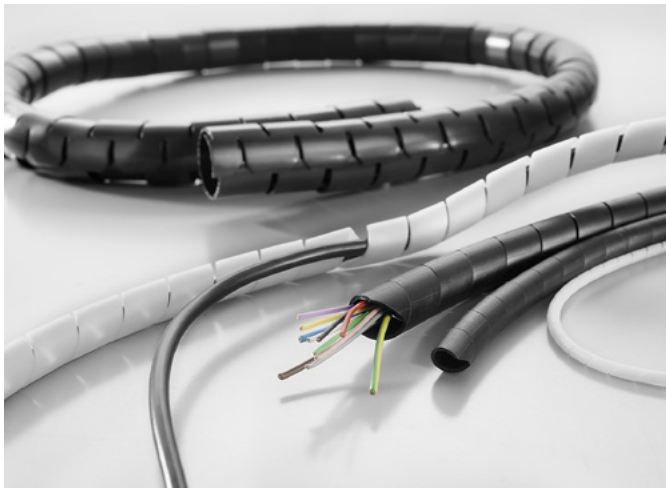

### Cable protection conduits

Spiral and webbing hoses are particularly suitable for the construction of space-saving cable routing systems in switch gears and control cabinets. They are used for guiding, protecting and bundling cables and wires - for example, in the transition between the enclosure interior and the door.

More flexibility and efficiency with holders and separators for simple assembly.

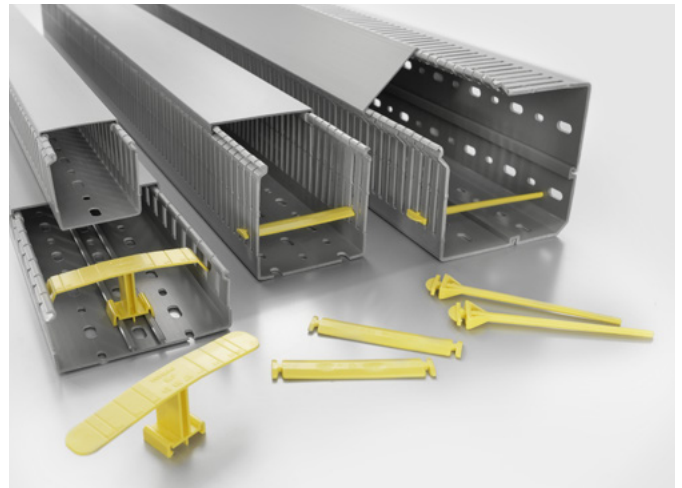

### Accessories

With our practical accessories, you can prevent already installed cables and wires from falling out of the cabinet. This simplifies assembly and saves time. Data and power cables can be separated from each other with dividers in the same channel. The covers are also available as accessories and can be ordered individually if required.



# Optimum design flexibility allows clear and simple identification

## Marking solutions from Weidmüller

The internal order of a cabinet must be assessed at a glance during service work. Therefore, clear identification of the installed components is necessary. As a perfect complement to our wiring channels, MultiMark provides you with a complete system of appropriate marking solutions.

MultiMark endless labels for an economical and flexible marking via thermal transfer printing.

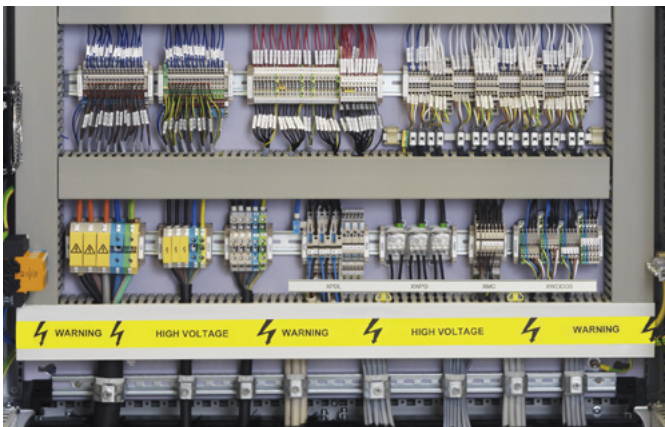

### MultiMark labels

MultiMark endless labels are an economical alternative to conventional tag rails or special labels, and can be printed with our thermal transfer printer THM MultiMark. They have a predefined width and its length can be adjusted exactly to the length of text created by the printer software. A cutter that can be attached to the printer, cuts the labels individually to the specified size. Ideal for large area marking of function or terminal blocks.

The universal tag rails can be securely attached to wiring ducts with glue.



### MultiCard and tag rails

Particularly in the case of aligned modular devices, our tag rails are ideal for clear marking with high contrast. Our tag rails made of sturdy PVC are equipped with secure locking MultiCard markers which easily snap in.

#### Your advantages:

- Simple assignment of supplementary information on the equipment
- Custom lengths as the material is available on the roll and cut according to the requirements
- Flexible thanks to the use of Weidmüller labelling systems

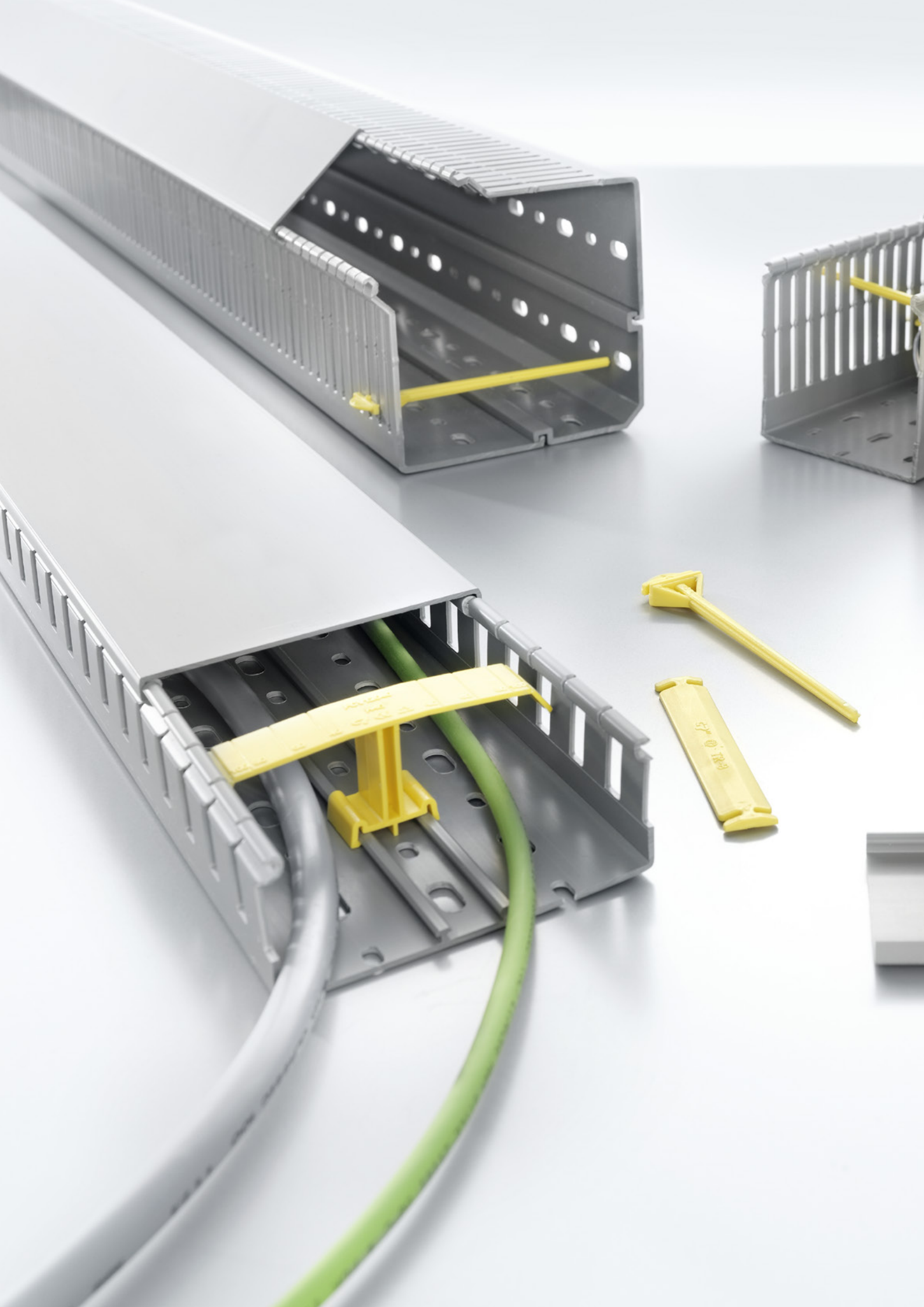

# Ordering data

## Metric cable duct, slit width 8 / slit clearance 12

### Technical data

Material	Colour	Length	Operating temperature	Fire class acc. to UL 94
PVC	Grey	2000 mm	-5...60 °C	V-0

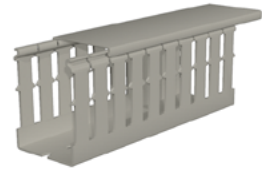

### Ordering data

Order No.	Type	Height	Width	Slit width	Slit gap	Qty.
2552600000	CD 30x25 8/12	30 mm	25 mm	8.00 mm	12.00 mm	40
2552660000	CD 30x40 8/12	30 mm	40 mm	8.00 mm	12.00 mm	24
2552710000	CD 30x60 8/12	30 mm	60 mm	8.00 mm	12.00 mm	16
2552620000	CD 40x25 8/12	40 mm	25 mm	8.00 mm	12.00 mm	30
2552670000	CD 40x40 8/12	40 mm	40 mm	8.00 mm	12.00 mm	20
2552720000	CD 40x60 8/12	40 mm	60 mm	8.00 mm	12.00 mm	12
2552760000	CD 40x80 8/12	40 mm	80 mm	8.00 mm	12.00 mm	12
2552800000	CD 40x100 8/12*	40 mm	100 mm	8.00 mm	12.00 mm	8
2552850000	CD 40x120 8/12*	40 mm	120 mm	8.00 mm	12.00 mm	10
2552630000	CD 60x25 8/12	60 mm	25 mm	8.00 mm	12.00 mm	20
2552680000	CD 60x40 8/12	60 mm	40 mm	8.00 mm	12.00 mm	18
2552730000	CD 60x60 8/12	60 mm	60 mm	8.00 mm	12.00 mm	12
2552770000	CD 60x80 8/12	60 mm	80 mm	8.00 mm	12.00 mm	12
2552810000	CD 60x100 8/12	60 mm	100 mm	8.00 mm	12.00 mm	10
2552860000	CD 60x120 8/12*	60 mm	120 mm	8.00 mm	12.00 mm	8
2552890000	CD 60x150 8/12*	60 mm	150 mm	8.00 mm	12.00 mm	6
2552920000	CD 60x200 8/12*	60 mm	200 mm	8.00 mm	12.00 mm	4
2552640000	CD 80x25 8/12	80 mm	25 mm	8.00 mm	12.00 mm	16
2552690000	CD 80x40 8/12	80 mm	40 mm	8.00 mm	12.00 mm	12
2552740000	CD 80x60 8/12	80 mm	60 mm	8.00 mm	12.00 mm	12
2552780000	CD 80x80 8/12	80 mm	80 mm	8.00 mm	12.00 mm	12
2552820000	CD 80x100 8/12	80 mm	100 mm	8.00 mm	12.00 mm	8
2552870000	CD 80x120 8/12*	80 mm	120 mm	8.00 mm	12.00 mm	8
2552900000	CD 80x150 8/12*	80 mm	150 mm	8.00 mm	12.00 mm	6
2552930000	CD 80x200 8/12*	80 mm	200 mm	8.00 mm	12.00 mm	4
2552650000	CD 100x25 8/12	100 mm	25 mm	8.00 mm	12.00 mm	12
2552700000	CD 100x40 8/12	100 mm	40 mm	8.00 mm	12.00 mm	8
2552750000	CD 100x60 8/12	100 mm	60 mm	8.00 mm	12.00 mm	8
2552790000	CD 100x80 8/12*	100 mm	80 mm	8.00 mm	12.00 mm	8
2552830000	CD 100x100 8/12*	100 mm	100 mm	8.00 mm	12.00 mm	8
2552880000	CD 100x120 8/12*	100 mm	120 mm	8.00 mm	12.00 mm	4
2552910000	CD 100x150 8/12*	100 mm	150 mm	8.00 mm	12.00 mm	4
2552940000	CD 100x200 8/12*	100 mm	200 mm	8.00 mm	12.00 mm	4
2552840000	CD 150x100 8/12	150 mm	100 mm	8.00 mm	12.00 mm	4

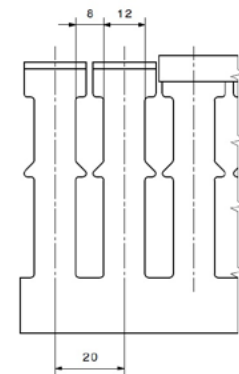

\* with floor duct, see page 17



## Metric cable duct, slit width 4 / slit clearance 6

### Technical data

Material	Colour	Length	Operating temperature	Fire class acc. to UL 94
PVC	Grey	2000 mm	-5...60 °C	V-0

### Ordering data

Order No.	Type	Height	Width	Slit width	Slit gap	Qty.
2552950000	CD 17x15 4/6	17 mm	15 mm	4.00 mm	6.00 mm	60
2552960000	CD 30x15 4/6	30 mm	15 mm	4.00 mm	6.00 mm	48
2552980000	CD 30x25 4/6	30 mm	25 mm	4.00 mm	6.00 mm	40
2552970000	CD 40x15 4/6	40 mm	15 mm	4.00 mm	6.00 mm	36
2552990000	CD 40x25 4/6	40 mm	25 mm	4.00 mm	6.00 mm	30
2553030000	CD 40x40 4/6	40 mm	40 mm	4.00 mm	6.00 mm	20
2553070000	CD 40x60 4/6	40 mm	60 mm	4.00 mm	6.00 mm	12
2553110000	CD 40x80 4/6	40 mm	80 mm	4.00 mm	6.00 mm	12
2553000000	CD 60x25 4/6	60 mm	25 mm	4.00 mm	6.00 mm	20
2553040000	CD 60x40 4/6	60 mm	40 mm	4.00 mm	6.00 mm	18
2553080000	CD 60x60 4/6	60 mm	60 mm	4.00 mm	6.00 mm	12
2553120000	CD 60x80 4/6	60 mm	80 mm	4.00 mm	6.00 mm	12
2553150000	CD 60x100 4/6	60 mm	100 mm	4.00 mm	6.00 mm	10
2553180000	CD 60x120 4/6*	60 mm	120 mm	4.00 mm	6.00 mm	8
2553010000	CD 80x25 4/6	80 mm	25 mm	4.00 mm	6.00 mm	16
2553050000	CD 80x40 4/6	80 mm	40 mm	4.00 mm	6.00 mm	12
2553090000	CD 80x60 4/6	80 mm	60 mm	4.00 mm	6.00 mm	12
2553130000	CD 80x80 4/6	80 mm	80 mm	4.00 mm	6.00 mm	12
2553160000	CD 80x100 4/6	80 mm	100 mm	4.00 mm	6.00 mm	8
2553190000	CD 80x120 4/6*	80 mm	120 mm	4.00 mm	6.00 mm	8
2553020000	CD 100x25 4/6	100 mm	25 mm	4.00 mm	6.00 mm	12
2553060000	CD 100x40 4/6	100 mm	40 mm	4.00 mm	6.00 mm	8
2553100000	CD 100x60 4/6	100 mm	60 mm	4.00 mm	6.00 mm	8
2553140000	CD 100x80 4/6*	100 mm	80 mm	4.00 mm	6.00 mm	8
2553170000	CD 100x100 4/6*	100 mm	100 mm	4.00 mm	6.00 mm	8
2553200000	CD 100x120 4/6*	100 mm	120 mm	4.00 mm	6.00 mm	4

\* with floor duct, see page 18

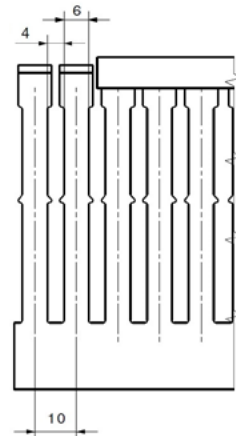

## Metric cable duct corner duct, slit width 4 / slit clearance 6

### Technical data

Material	Colour	Length	Operating temperature	Fire class acc. to UL 94
PVC	Grey	2000 mm	-5...60 °C	V-0

### Ordering data

Order No.	Type	Height	Width	Slit width	Slit gap	Qty.
2554530000	CD-CDD 90x90 4/6	90 mm	90 mm	4.00 mm	6.00 mm	8
2554540000	CD-CDD 110x110 4/6	110 mm	110 mm	4.00 mm	6.00 mm	8

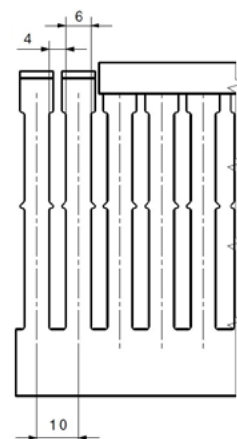
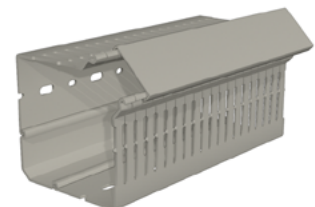

## DIN cable duct, slit width 5 / slit clearance 7.5

### Technical data

Material	Colour	Length	Operating temperature	Fire class acc. to UL 94
PVC	Grey	2000 mm	-5...60 °C	V-0

### Ordering data

Order No.	Type	Height	Width	Slit width	Slit gap	Qty.
2553210000	CD 25x25 5/7.5	25 mm	25 mm	5.00 mm	7.50 mm	42
2553220000	CD 37.5x25 5/7.5	37.5 mm	25 mm	5.00 mm	7.50 mm	32
2553250000	CD 37.5x37.5 5/7.5	37.5 mm	37.5 mm	5.00 mm	7.50 mm	24
2553230000	CD 50x25 5/7.5	50 mm	25 mm	5.00 mm	7.50 mm	26
2553260000	CD 50x37.5 5/7.5	50 mm	37.5 mm	5.00 mm	7.50 mm	16
2554130000	CD 50x50 5/7.5	50 mm	50 mm	5.00 mm	7.50 mm	12
2554150000	CD 50x75 5/7.5	50 mm	75 mm	5.00 mm	7.50 mm	12
2554170000	CD 50x100 5/7.5	50 mm	100 mm	5.00 mm	7.50 mm	8
2553240000	CD 75x25 5/7.5	75 mm	25 mm	5.00 mm	7.50 mm	16
2553270000	CD 75x37.5 5/7.5	75 mm	37.5 mm	5.00 mm	7.50 mm	16
2554140000	CD 75x50 5/7.5	75 mm	50 mm	5.00 mm	7.50 mm	12
2554160000	CD 75x75 5/7.5	75 mm	75 mm	5.00 mm	7.50 mm	8
2554180000	CD 75x100 5/7.5	75 mm	100 mm	5.00 mm	7.50 mm	8
2554190000	CD 75x125 5/7.5	75 mm	125 mm	5.00 mm	7.50 mm	6

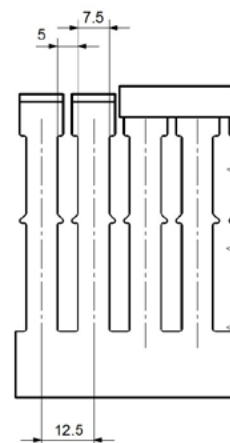
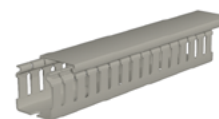

## Halogen-free cable duct, light grey, slit width 5 / slit clearance 7.5

### Technical data

Material	Colour	Length	Operating temperature	Fire class acc. to UL 94
PC	Light Grey	2000 mm	-25...100 °C	V-0

### Ordering data

Order No.	Type	Height	Width	Slit width	Slit gap	Qty.
2552610000	CD-HF 25x25 5/7.5 L	25 mm	25 mm	5.00 mm	7.50 mm	42
2553280000	CD-HF 37.5x25 5/7.5 L	37.5 mm	25 mm	5.00 mm	7.50 mm	32
2553310000	CD-HF 37.5x37.5 5/7.5 L	37.5 mm	37.5 mm	5.00 mm	7.50 mm	24
2553290000	CD-HF 50x25 5/7.5 L	50 mm	25 mm	5.00 mm	7.50 mm	26
2553320000	CD-HF 50x37.5 5/7.5 L	50 mm	37.5 mm	5.00 mm	7.50 mm	16
2553340000	CD-HF 50x50 5/7.5 L	50 mm	50 mm	5.00 mm	7.50 mm	12
2553360000	CD-HF 50x75 5/7.5 L	50 mm	75 mm	5.00 mm	7.50 mm	12
2553380000	CD-HF 50x100 5/7.5 L	50 mm	100 mm	5.00 mm	7.50 mm	8
2553300000	CD-HF 75x25 5/7.5 L	75 mm	25 mm	5.00 mm	7.50 mm	16
2553330000	CD-HF 75x37.5 5/7.5 L	75 mm	37.5 mm	5.00 mm	7.50 mm	16
2553350000	CD-HF 75x50 5/7.5 L	75 mm	50 mm	5.00 mm	7.50 mm	12
2553370000	CD-HF 75x75 5/7.5 L	75 mm	75 mm	5.00 mm	7.50 mm	8
2553390000	CD-HF 75x100 5/7.5 L	75 mm	100 mm	5.00 mm	7.50 mm	8
2553400000	CD-HF 75x125 5/7.5 L	75 mm	125 mm	5.00 mm	7.50 mm	6

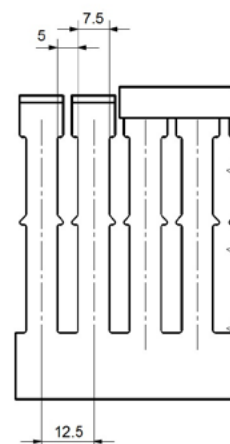

## Halogen-free cable duct, dark grey, slit width 5 / slit clearance 7.5



### Technical data

Material	Colour	Length	Operating temperature	Fire class acc. to UL 94
PPE + PS	dark grey	2000 mm	-25...120 °C	V-0

### Ordering data

Order No.	Type	Height	Width	Slit width	Slit gap	Qty.
2553410000	CD-HF 25x25 5/7.5 D	25 mm	25 mm	5.00 mm	7.50 mm	42
2553420000	CD-HF 37.5x25 5/7.5 D	37.5 mm	25 mm	5.00 mm	7.50 mm	32
2553450000	CD-HF 37.5x37.5 5/7.5 D	37.5 mm	37.5 mm	5.00 mm	7.50 mm	24
2553430000	CD-HF 50x25 5/7.5 D	50 mm	25 mm	5.00 mm	7.50 mm	26
2553460000	CD-HF 50x37.5 5/7.5 D	50 mm	37.5 mm	5.00 mm	7.50 mm	16
2553480000	CD-HF 50x50 5/7.5 D	50 mm	50 mm	5.00 mm	7.50 mm	12
2553500000	CD-HF 50x75 5/7.5 D	50 mm	75 mm	5.00 mm	7.50 mm	12
2553520000	CD-HF 50x100 5/7.5 D	50 mm	100 mm	5.00 mm	7.50 mm	8
2553440000	CD-HF 75x25 5/7.5 D	75 mm	25 mm	5.00 mm	7.50 mm	16
2553470000	CD-HF 75x37.5 5/7.5 D	75 mm	37.5 mm	5.00 mm	7.50 mm	16
2553490000	CD-HF 75x50 5/7.5 D	75 mm	50 mm	5.00 mm	7.50 mm	12
2553510000	CD-HF 75x75 5/7.5 D	75 mm	75 mm	5.00 mm	7.50 mm	8
2553530000	CD-HF 75x100 5/7.5 D	75 mm	100 mm	5.00 mm	7.50 mm	8
2553540000	CD-HF 75x125 5/7.5 D	75 mm	125 mm	5.00 mm	7.50 mm	6

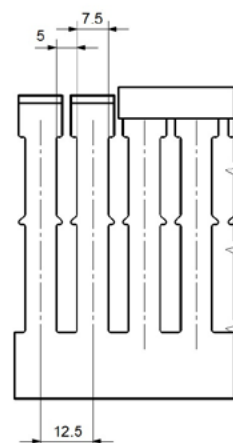
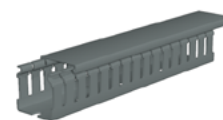

## Cable duct floor duct

### Technical data

Material	Colour	Length	Operating temperature	Fire class acc. to UL 94
PVC	Grey	2000 mm	-5...60 °C	V-0

### Ordering data

Order No.	Type	Height	Width	Slit width	Slit gap	Qty.
2554450000	CD-BO 40x60 4/6	40 mm	60 mm	4.00 mm	6.00 mm	12
2554350000	CD-BO 40x60 8/12	40 mm	60 mm	8.00 mm	12.00 mm	12
2554480000	CD-BO 40x80 4/6	40 mm	80 mm	4.00 mm	6.00 mm	12
2554380000	CD-BO 40x80 8/12	40 mm	80 mm	8.00 mm	12.00 mm	12
2554430000	CD-BO 60x40 4/6	60 mm	40 mm	4.00 mm	6.00 mm	18
2554330000	CD-BO 60x40 8/12	60 mm	40 mm	8.00 mm	12.00 mm	18
2554460000	CD-BO 60x60 4/6	60 mm	60 mm	4.00 mm	6.00 mm	12
2554360000	CD-BO 60x60 8/12	60 mm	60 mm	8.00 mm	12.00 mm	12
2554490000	CD-BO 60x80 4/6	60 mm	80 mm	4.00 mm	6.00 mm	12
2554390000	CD-BO 60x80 8/12	60 mm	80 mm	8.00 mm	12.00 mm	12
2554510000	CD-BO 60x100 4/6	60 mm	100 mm	4.00 mm	6.00 mm	10
2554410000	CD-BO 60x100 8/12	60 mm	100 mm	8.00 mm	12.00 mm	10
2554440000	CD-BO 80x40 4/6	80 mm	40 mm	4.00 mm	6.00 mm	12
2554340000	CD-BO 80x40 8/12	80 mm	40 mm	8.00 mm	12.00 mm	12
2554470000	CD-BO 80x60 4/6	80 mm	60 mm	4.00 mm	6.00 mm	12
2554370000	CD-BO 80x60 8/12	80 mm	60 mm	8.00 mm	12.00 mm	12
2554500000	CD-BO 80x80 4/6	80 mm	80 mm	4.00 mm	6.00 mm	12
2554400000	CD-BO 80x80 8/12	80 mm	80 mm	8.00 mm	12.00 mm	12
2554520000	CD-BO 80x100 4/6	80 mm	100 mm	4.00 mm	6.00 mm	8
2554420000	CD-BO 80x100 8/12	80 mm	100 mm	8.00 mm	12.00 mm	8

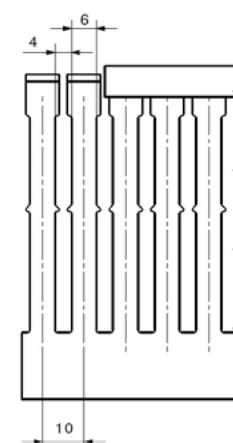
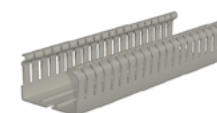

## Accessories cable duct cover

### Technical data

Material	Length	Operating temperature	Fire class acc. to UL 94
PVC	2000 mm	-5...60 °C	V-0

### Ordering data

Order No.	Type	Width	Colour	Qty.
2554200000	CD-LID 15	15 mm	Grey	1
2554210000	CD-LID 25	25 mm	Grey	1
2554220000	CD-LID 37.5	37.5 mm	Grey	1
2554230000	CD-LID 40	40 mm	Grey	1
2554240000	CD-LID 50	50 mm	Grey	1
2554250000	CD-LID 60	60 mm	Grey	1
2554260000	CD-LID 75	75 mm	Grey	1
2554270000	CD-LID 80	80 mm	Grey	1
2554280000	CD-LID 100	100 mm	Grey	1
2554290000	CD-LID 120	120 mm	Grey	1
2554300000	CD-LID 125	125 mm	Grey	1
2554310000	CD-LID 150	150 mm	Grey	1
2554320000	CD-LID 200	200 mm	Grey	1



## Accessories halogen-free cable duct cover

### Technical data

Material	Length	Operating temperature	Fire class acc. to UL 94
PC	2000 mm	-25...100 °C	V-0



### Ordering data

Order No.	Type	Width	Colour	Qty.
2553550000	CD-LID 25 L	25 mm	Light Grey	1
2553560000	CD-LID 37.5 L	37.5 mm	Light Grey	1
2553570000	CD-LID 50 L	50 mm	Light Grey	1
2553580000	CD-LID 75 L	75 mm	Light Grey	1
2553590000	CD-LID 100 L	100 mm	Light Grey	1
2553600000	CD-LID 125 L	125 mm	Light Grey	1



## Accessories halogen-free cable duct cover

### Technical data

Material	Length	Operating temperature	Fire class acc. to UL 94
PPE + PS	2000 mm	-25...120 °C	V-0



### Ordering data

Order No.	Type	Width	Colour	Qty.
2553610000	CD-LID 25 D	25 mm	dark grey	1
2553620000	CD-LID 37.5 D	37.5 mm	dark grey	1
2553630000	CD-LID 50 D	50 mm	dark grey	1
2553640000	CD-LID 75 D	75 mm	dark grey	1
2553650000	CD-LID 100 D	100 mm	dark grey	1
2553660000	CD-LID 125 D	125 mm	dark grey	1



## Cable duct accessories holders

### Technical data

Material	Operating temperature	Fire class acc. to UL 94
Polyamide 6 (PA 6)	-40...100 °C	HB

### Ordering data

Order No.	Type	Product type	Colour	Length	Qty.
2554100000	CD-RETA 60	Cable duct T-form binder	Yellow		25
2554090000	CD-RETA 40	Cable duct T-form binder	Yellow		40
2554080000	CD-RETT	Cable duct binder arm	Yellow		100
2554050000	CD-RET 80	Cable duct binder	Yellow		400
2554030000	CD-RET 60	Cable duct binder	Yellow		500
2554020000	CD-RET 40	Cable duct binder	Yellow		500
2554070000	CD-RET 125	Cable duct binder	Yellow		200
2554060000	CD-RET 100/120	Cable duct binder	Yellow		250



## Cable duct accessories separators

### Technical data

Material	Operating temperature	Fire class acc. to UL 94
PVC	-5...60 °C	V-0

### Ordering data

Order No.	Type	Product type	Colour	Length	Qty.
2554000000	CD-SCCV	Cable duct screw cover	Grey		1000
2553980000	CD-SE 80	Cable duct separator	Grey	1000 mm	16
2553960000	CD-SE 60	Cable duct separator	Grey	1000 mm	25
2553950000	CD-SE 40/2	Cable duct separator	Grey	1000 mm	30
2553970000	CD-SE 40	Cable duct separator	Grey	1000 mm	30
2553990000	CD-SE 100	Cable duct separator	Grey	1000 mm	16



## Accessories rivets and Expanding-rivet tool

### Technical data

Material	Height	Diameter	Weight
Aluminium	224 mm	34 mm	142 g

### Ordering data

Order No.	Type	Product type	Drill-hole diameter	Colour	Qty.
2562710000	RXRV-T 6.5	Expanding-rivet tool	6.5 mm	Silver, Black	4
2562720000	RXRV-T 4.5	Expanding-rivet tool	4.5 mm	Silver, Green	4

### Accessories

Order No.	Type	Product type	Drill-hole diameter	Colour	Qty.
2562690000	RXRV 6.5	Expanding rivet	6.5 mm	Black	1000
2562700000	RXRV 4.5	Expanding rivet	4.5 mm	Green	1000





## Cable duct cutting device

### Technical data

Weight	Width	Height	Depth
15000 g	280 mm	285 mm	290 mm

### Ordering data

Order No.	Type	Product type	Cutting width max.	Qty.
1137530000	VKSW	Cable duct cutting device	125 mm	1



## Accessories cable duct marker

### Technical data

Material	Operating temperature	Fire class acc. to UL 94
PVC	-5...60 °C	V-0

### Ordering data

Order No.	Type	Product type	Height	Colour	Length	Qty.
2554120000	CD-LBK	Cable duct tag rail kit	30 mm	Yellow, Grey	1000 mm	20
2562850000	CD-LBH	Cable duct tag rail holder	30 mm	Yellow	25 mm	150
2562680000	CD-LB	Cable duct tag rail	15 mm	Grey	1000 mm	150



## Accessories

Order No.	Type	Product type	Height	Colour	Length	Qty.
2006580000	EL 12 MM GE 30M	Device markers	12 mm	Yellow	30000 mm	1
2006560000	EL 12 MM SI 30M	Device markers	12 mm	Silver	30000 mm	1
2006570000	EL 12 MM WS 30M	Device markers	12 mm	White	30000 mm	1

## CC-RAIL 1000

### Technical data

Material	Operating temperature	Fire class acc. to UL 94	Version
PVC	-20...80 °C	V-0	Self-adhesive

### Ordering data

Order No.	Type	Product type	Width	Colour	Height	Qty.
1790150000	CC-RAIL 1000	Accessories	17 mm	Black	1000 mm	1

## Accessories

Order No.	Type	Product type	Width	Colour	Height	Qty.
1876570000	CC 15/17 MC NE WS	Device markers	17 mm	White	15 mm	80
1876770000	CC 15/27 MC NE WS	Device markers	27 mm	White	15 mm	80
1877260000	CC 15/49 MC NE WS	Device markers	49 mm	White	15 mm	40
1877350000	CC 15/60 MC NE WS	Device markers	60 mm	White	15 mm	40
1790160000	CC-RAIL TRANSPARENT1000	Cover	19 mm	Transparent	1000 mm	1



## SCHS 2

### Technical data

Material	Operating temperature	Fire class acc. to UL 94	Version
PVC	-20...80 °C	V-0	Self-adhesive

### Ordering data

Order No.	Type	Product type	Width	Colour	Height	Qty.
1720600000	SCHS2 K	Accessories	8 mm	Black	1000 mm	1

### Accessories

Order No.	Type	Product type	Width	Colour	Height	Qty.
1755340000	ESG 8/17 SYS PRO M WS	Device markers	8 mm	White	17 mm	200
1609801044	DEK 5/5 MC NE WS	Terminal marker	5 mm	White	5 mm	1000
1640740000	WS 8/5 MC NE WS	Terminal marker	5 mm	White	8 mm	720



## SCHS 3 + SCHS 4

### Technical data

Material	Operating temperature	Fire class acc. to UL 94	Version
PVC	-20...80 °C	V-0	Self-adhesive

### Ordering data

Order No.	Type	Product type	Width	Colour	Height	Qty.
1753480000	SCHS3 K	Accessories	10 mm	Black	1000 mm	1
1753460000	SCHS4 K	Accessories	10 mm	Grey	1000 mm	1

### Accessories

Order No.	Type	Product type	Width	Colour	Height	Qty.
1736181687	ESG 7/20 SIRIUS MC NE GE	Device markers	7 mm	Yellow	20 mm	200



## Flexible cable duct

### Technical data

Material	Colour	Length	Operating temperature	Fire class acc. to UL 94
PA	grey (similar to RAL 7001)	500	-15...80 °C	V-0

### Ordering data

Order No.	Type	Height	Width	Slit width	Slit gap	Qty.
2562770000	CD-FLEX 12.5x12.5	12.5 mm	12.5 mm	5.00 mm	7.50 mm	50
2562780000	CD-FLEX 20x20	20 mm	20 mm	5.00 mm	7.50 mm	50
2562790000	CD-FLEX 30x30	30 mm	30 mm	5.00 mm	7.50 mm	50
2562800000	CD-FLEX 40x40	40 mm	40 mm	5.00 mm	7.50 mm	50



## Protective cable hose coil

### Technical data

Material	Operating temperature	Fire class acc. to UL 94
Polyethylene	-15...60 °C	V-2

### Ordering data

Order No.	Type	Nominal diameter	Bundle diameter	Colour	Length	Qty.
2553740000	CBSH-SP 8-70/100 T	6 mm	8...70 mm	Transparent	100000 mm	1
2553840000	CBSH-SP 8-70/100 B	6 mm	8...70 mm	black, RAL 7021	100000 mm	1
2553790000	CBSH-SP 5-50/200 V2 T	4.2 mm	5...50 mm	Transparent	200000 mm	1
2553730000	CBSH-SP 5-50/200 T	4.2 mm	5...50 mm	Transparent	200000 mm	1
2553830000	CBSH-SP 5-50/200 B	4.2 mm	5...50 mm	black, RAL 7021	200000 mm	1
2553780000	CBSH-SP 2-12/400 V2 T	1.5 mm	2...12 mm	Transparent	400000 mm	1
2553720000	CBSH-SP 2-12/400 T	1.5 mm	2...12 mm	Transparent	400000 mm	1
2553820000	CBSH-SP 2-12/400 B	1.5 mm	2...12 mm	black, RAL 7021	400000 mm	1
2553770000	CBSH-SP 18-140/60 T	11.6 mm	18...140 mm	Transparent	60000 mm	1
2553810000	CBSH-SP 14-120/100 V2 T	9.6 mm	14...120 mm	Transparent	100000 mm	1
2553760000	CBSH-SP 14-120/100 T	9.6 mm	14...120 mm	Transparent	100000 mm	1
2553860000	CBSH-SP 14-120/100 B	9.6 mm	14...120 mm	black, RAL 7021	100000 mm	1
2553800000	CBSH-SP 12-100/100 V2 T	7.6 mm	12...100 mm	Transparent	100000 mm	1
2553750000	CBSH-SP 12-100/100 T	7.6 mm	12...100 mm	Transparent	100000 mm	1
2553850000	CBSH-SP 12-100/100 B	7.6 mm	12...100 mm	black, RAL 7021	100000 mm	1



## Protective cable hose and tools

### Technical data

Material	Operating temperature	Fire class acc. to UL 94
Polypropylene	-20...90 °C	HB

### Ordering data

Order No.	Type	Nominal diameter	Bundle diameter	Colour	Length	Qty.
2553870000	CBSH 8/100	8 mm	8 mm	black, RAL 7021	100000 mm	1
2553900000	CBSH 25/20	25 mm	25 mm	black, RAL 7021	20000 mm	1
2553890000	CBSH 20/30	20 mm	20 mm	black, RAL 7021	30000 mm	1
2553880000	CBSH 15/50	15 mm	15 mm	black, RAL 7021	50000 mm	1



### Accessories

Order No.	Type	Product type	Diameter	Colour	Qty.
2553910000	CBSH-T 8	Protective cable hose tool	8	Green	10
2553920000	CBSH-T 15	Protective cable hose tool	15	Green	10
2553930000	CBSH-T 20	Protective cable hose tool	20	Green	10
2553940000	CBSH-T 25	Protective cable hose tool	25	Green	5



## Protective fabric-reinforced cable hose

### Technical data

Material	Operating temperature	Fire class acc. to UL 94
Polyethylene terephthalate PET	-50...150 °C	HB

### Ordering data

Order No.	Type	Nominal diameter	Bundle diameter	Colour	Length	Qty.
2553670000	CBSH-FB 5-10/200	5 mm	5...10 mm	Silver grey	100000 mm	1
2553680000	CBSH-FB 10-18/200	10 mm	10...18 mm	Silver grey	200000 mm	1
2553690000	CBSH-FB 20-30/100	20 mm	20...30 mm	Silver grey	100000 mm	1
2553700000	CBSH-FB 30-45/100	30 mm	30...45 mm	Silver grey	100000 mm	1
2553710000	CBSH-FB 50-75/50	50 mm	50...75 mm	Silver grey	50000 mm	1

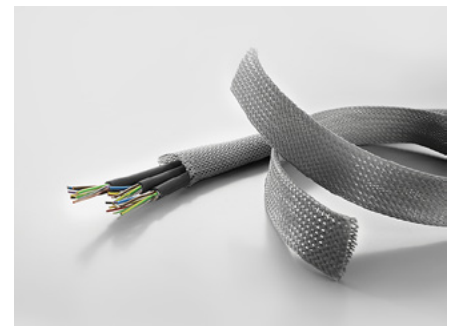

# Technical Data

## Sizes of holes on the bottom, cable ducts metric, slit width 8 / distance of slots 12

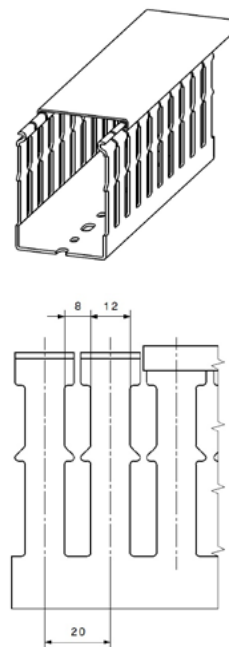
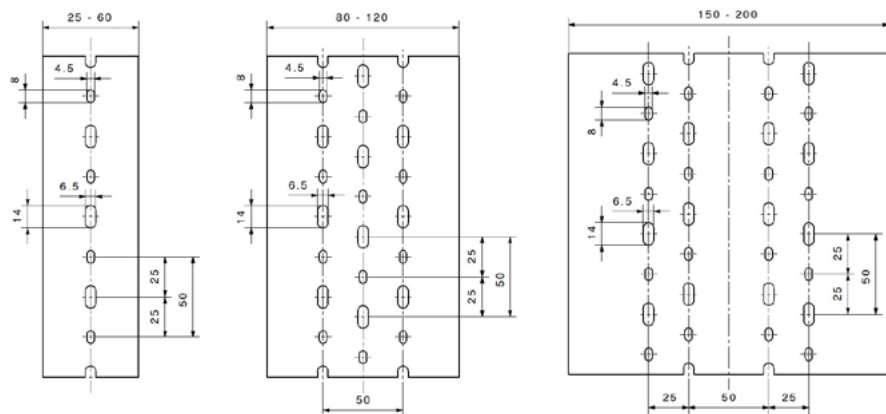

## Bottom rails, cable ducts metric, slit width 8 / distance of slots 12

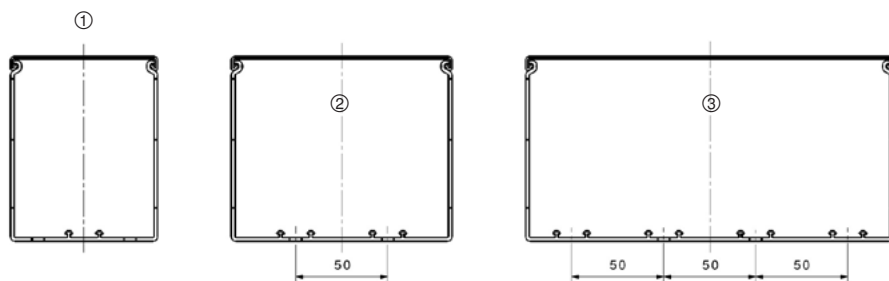

Order No.	Type	Height	Width	Number of bottom rails	Figure
2554350000	CD-BO 40x60 8/12	40	60	1	1
2554380000	CD-BO 40x80 8/12	40	80	1	1
2554330000	CD-BO 60x40 8/12	60	40	1	1
2554360000	CD-BO 60x60 8/12	60	60	1	1
2554390000	CD-BO 60x80 8/12	60	80	1	1
2554410000	CD-BO 60x100 8/12	60	100	1	1
2554340000	CD-BO 80x40 8/12	80	40	1	1
2554370000	CD-BO 80x60 8/12	80	60	1	1
2554400000	CD-BO 80x80 8/12	80	80	1	1
2554420000	CD-BO 80x100 8/12	80	100	1	1
2552800000	CD 40x100 8/12	40	100	1	1
2552850000	CD 40x120 8/12	40	120	2	2
2552860000	CD 60x120 8/12	60	120	2	2
2552890000	CD 60x150 8/12	60	150	2	2
2552920000	CD 60x200 8/12	60	200	4	3
2552870000	CD 80x120 8/12	80	120	2	2
2552900000	CD 80x150 8/12	80	150	2	2
2552930000	CD 80x200 8/12	80	200	4	3
2552790000	CD 100x80 8/12	100	80	1	1
2552830000	CD 100x100 8/12	100	100	1	1
2552880000	CD 100x120 8/12	100	120	2	2
2552910000	CD 100x150 8/12	100	150	2	2
2552940000	CD 100x200 8/12	100	200	4	3

**Sizes of holes on the bottom, cable ducts metric, slit width 4 / distance of slots 6**

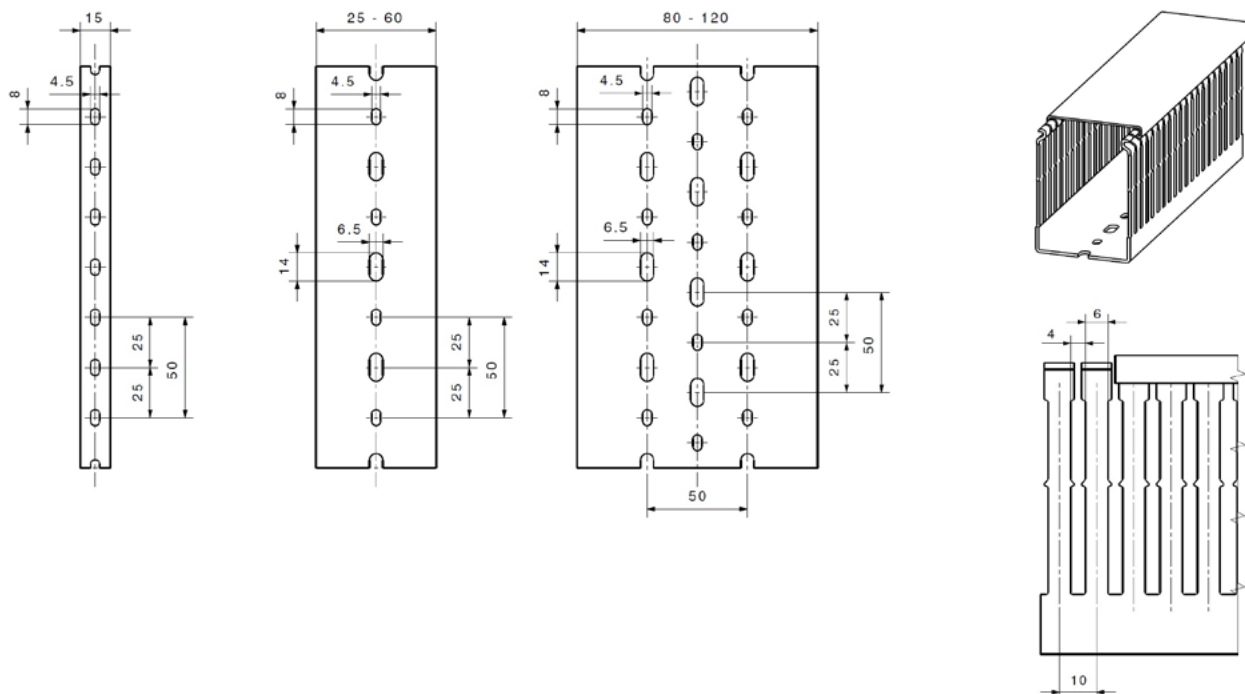

**Bottom rails, cable ducts metric, slit width 4 / distance of slots 6**

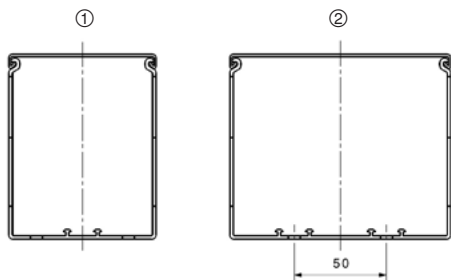

Order No.	Type	Height	Width	Number of bottom rails	Figure
2554450000	CD-BO 40x60 4/6	40	60	1	1
2554480000	CD-BO 40x80 4/6	40	80	1	1
2554430000	CD-BO 60x40 4/6	60	40	1	1
2554460000	CD-BO 60x60 4/6	60	60	1	1
2554490000	CD-BO 60x80 4/6	60	80	1	1
2554510000	CD-BO 60x100 4/6	60	100	1	1
2554440000	CD-BO 80x40 4/6	80	40	1	1
2554470000	CD-BO 80x60 4/6	80	60	1	1
2554500000	CD-BO 80x80 4/6	80	80	1	1
2554520000	CD-BO 80x100 4/6	80	100	1	1
2553180000	CD 60x120 4/6	60	120	2	2
2553190000	CD 80x120 4/6	80	120	2	2
2553140000	CD 100x80 4/6	100	80	1	1
2553170000	CD 100x100 4/6	100	100	1	1
2553200000	CD 100x120 4/6	100	120	2	2



**Sizes of holes on the bottom, cable ducts metric, slit width 5 / distance of slots 7.5**

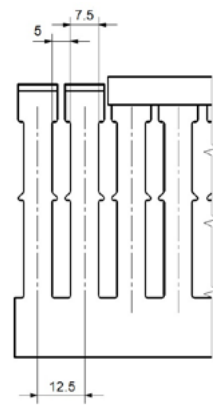
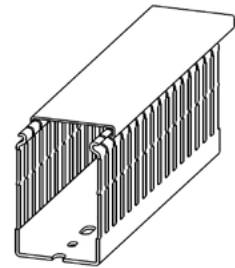
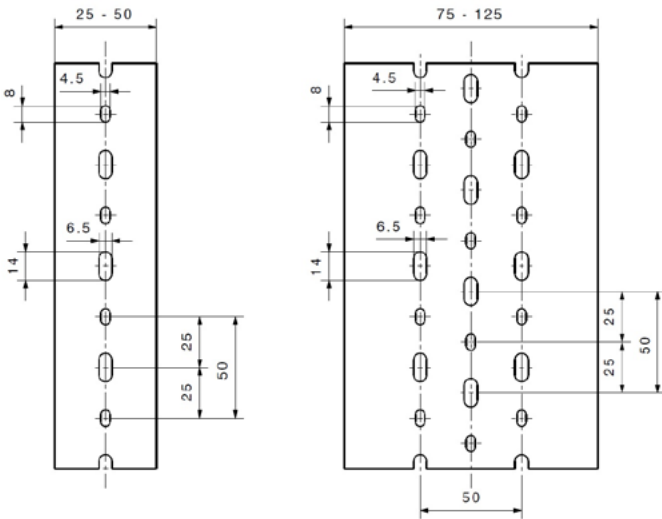

## Weidmüller – Your Partner in Industrial Connectivity

As experienced experts, we support our customers and partners around the world with products, solutions and services in the industrial environment of power, signal and data. We are at home in their industries and markets and know the technological challenges of tomorrow. We are therefore continuously developing innovative, sustainable and useful solutions for their individual needs. Together we set standards in industrial connectivity.

Weidmüller Interface GmbH & Co. KG  
Klingenbergstraße 16  
32758 Detmold, Germany  
T +49 5231 14-0  
F +49 5231 14-292083  
[www.weidmueller.com](http://www.weidmueller.com)

Personal support can  
be found on our website:  
[www.weidmueller.com/contact](http://www.weidmueller.com/contact)

Made in Germany



Order number: 2575300000/01/2018/SMR